

MC-CF - MITRED CORNER MODULE FOR CUSTOM FLOW

CORNER TYPE:

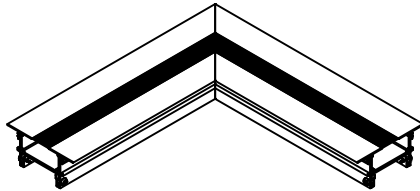

FLAT - Flat (In-Plane) Miter

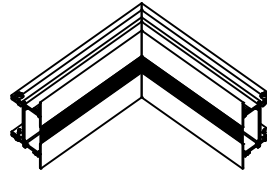

IC - Inside Corner

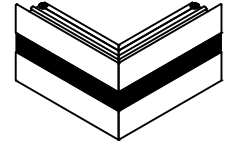

OC - Outside Corner

SLOT QUANTITY:

1 Slot

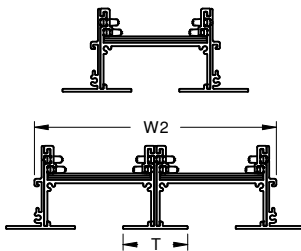

2 Slot

FRAME STYLE:

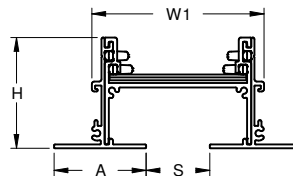

EF - Exposed Frame

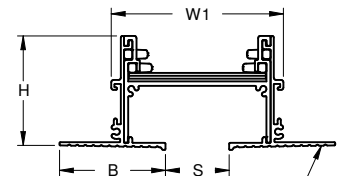

Tape and spackle to conceal frame (by others)

CMF - Concealed Mud Frame

Slot Width (S)	A	B	H	W1 (1 Slot)	W2 (2 Slot)	T
<input type="checkbox"/> 1" (25mm)	1 7/16" (37mm)	1 11/16" (43mm)	1 3/4" (44mm)	2 3/4" (70mm)	5 1/16" (129mm)	1 3/8" (35mm)
<input type="checkbox"/> 1 1/2" (38mm)	1 11/16" (43mm)	1 15/16" (49mm)	2" (51mm)	3 3/4" (95mm)	7 1/16" (179mm)	1 7/8" (48mm)
<input type="checkbox"/> 2" (51mm)	1 15/16" (49mm)	2 3/16" (56mm)	2 1/4" (57mm)	4 3/4" (121mm)	9 1/16" (230mm)	2 3/8" (60mm)
<input type="checkbox"/> 2 1/2" (64mm)	2 3/16" (56mm)	2 3/8" (60mm)	2 1/2" (64mm)	5 3/4" (146mm)	11 1/16" (281mm)	2 7/8" (73mm)
<input type="checkbox"/> 3" (76mm)	2 7/16" (62mm)	2 5/8" (67mm)	2 3/4" (70mm)	6 3/4" (171mm)	13 1/16" (332mm)	3 3/8" (86mm)

MOUNTING:

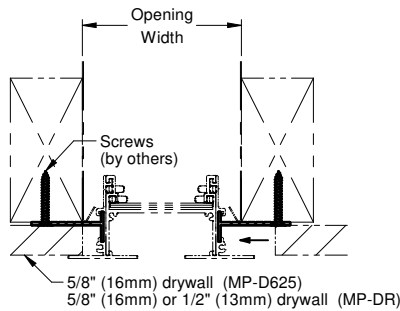

MP-D625 - Non-Rev. 5/8" Drywall Mtg. Clip

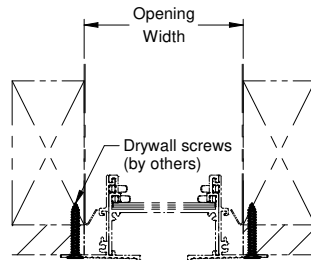

A - Countersunk Holes
• Only available with CMF frame

MP-DR - Reversible 1/2" or 5/8" Drywall Mtg. Clip

Slot Width	Slot Qty.	Opening Width
1" (25mm)	1	3 3/8" (86mm)
	2	5 11/16" (144mm)
1 1/2" (38mm)	1	4 3/8" (111mm)
	2	7 11/16" (195mm)
2" (51mm)	1	5 3/8" (137mm)
	2	9 11/16" (246mm)
2 1/2" (64mm)	1	6 3/8" (162mm)
	2	11 11/16" (297mm)
3" (76mm)	1	7 3/8" (187mm)
	2	13 11/16" (348mm)

ALL METRIC DIMENSIONS () ARE SOFT CONVERTED. IMPERIAL DIMENSIONS ARE CONVERTED TO METRIC AND ROUNDED TO THE NEAREST MILLIMETER.

PROJECT:		 MC-CF MITRED CORNER MODULE FOR CUSTOM FLOW
ENGINEER:		
CUSTOMER:		
SUBMITTAL DATE:	SPEC. SYMBOL:	
		 269879 2023/11/06

MC-CF - MITRED CORNER MODULE FOR CUSTOM FLOW

MODULE DIMENSIONS:

NOMINAL ANGLE: _____

- Available from 45° to 150°
- 45° to 69° not available for 2 slot FLAT 2.0" to 3.0" slot width configurations

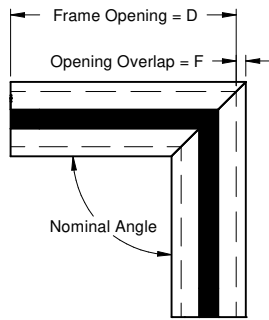

Flat (In-Plane Miter)

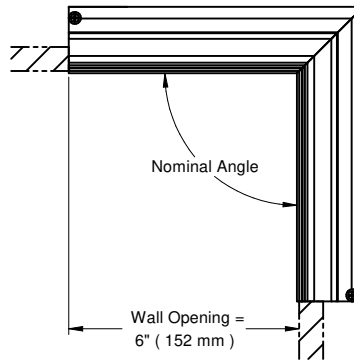

Inside Corner

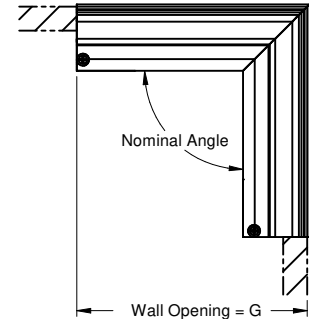

Outside Corner

Slot Width	Slot Qty.	D	
		45° - 69°	70° - 150°
1" (25mm)	1	18" (457mm)	12" (305mm)
	2	24" (610mm)	12" (305mm)
1 1/2" (38mm)	1	18" (457mm)	12" (305mm)
	2	24" (610mm)	18" (457mm)
2" (51mm)	1	18" (457mm)	12" (305mm)
	2	(n/a)	18" (457mm)
2 1/2" (64mm)	1	24" (610mm)	12" (305mm)
	2	(n/a)	18" (457mm)
3" (76mm)	1	24" (610mm)	18" (457mm)
	2	(n/a)	24" (610mm)

Frame Style	F
EF	1/4" (6mm)
CMF	1/2" (13mm)

Slot Width	G	
	45° - 69°	70° - 150°
1" (25mm)	6" (152mm)	6" (152mm)
1 1/2" (38mm)	9" (229mm)	6" (152mm)
2" (51mm)	9" (229mm)	6" (152mm)
2 1/2" (64mm)	9" (229mm)	6" (152mm)
3" (76mm)	9" (229mm)	6" (152mm)



MATERIAL:

- Extruded aluminum frame, spacers, and mounting clips
- Steel blankoffs
- Plastic locking pins
- Coated steel fasteners

NOTES:

- Mitered corner sections are blanked off
- (2) splice plates shipped loose with each unit
- For installation instructions, instructions for drywall finishing, or instructions for field trimming, please see the CF installation manual
- Taping and plaster finishing by others
- Only compatible with model CF diffusers
- Factory tolerance +/- 1/32" (1mm)

ALL METRIC DIMENSIONS () ARE SOFT CONVERTED. IMPERIAL DIMENSIONS ARE CONVERTED TO METRIC AND ROUNDED TO THE NEAREST MILLIMETER.

PROJECT:		  MC-CF MITRED CORNER MODULE FOR CUSTOM FLOW
ENGINEER:		
CUSTOMER:		
SUBMITTAL DATE:	SPEC. SYMBOL:	
		269879
		2023/11/06

MC-CF - MITRED CORNER MODULE FOR CUSTOM FLOW

FINISH:

• Diffuser face:

Standard Finishes:

- B12 - Standard white
- PA - Prepared and washed aluminum

Optional Finishes Available:

- Optional colors
- Custom colors
- Anodized
- Woodgrain patterns
- Armstrong coordinated finishes
- See finishes brochure for additional information. Contact your PRICE representative for leadtimes and pricing.

• CMF outer frames come with a PA finish. On 2 slot variations, only center tee will be painted.

• Interior surface:

- NO-BFR - Upper frame to match diffuser face

• Blank off plates - B17 black



Scan for link to additional product information and installation instructions.

ALL METRIC DIMENSIONS () ARE SOFT CONVERTED. IMPERIAL DIMENSIONS ARE CONVERTED TO METRIC AND ROUNDED TO THE NEAREST MILLIMETER.

PROJECT:		PRICE [®]	
ENGINEER:		<i>MG</i>	MC-CF MITRED CORNER MODULE FOR CUSTOM FLOW
CUSTOMER:		269879	
SUBMITTAL DATE:	SPEC. SYMBOL:	2023/11/06	